

SECTION A-A

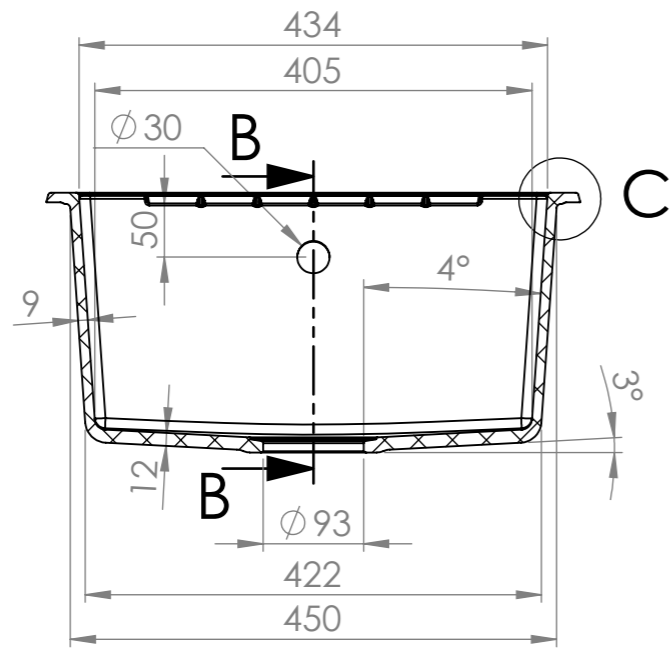

SECTION B-B

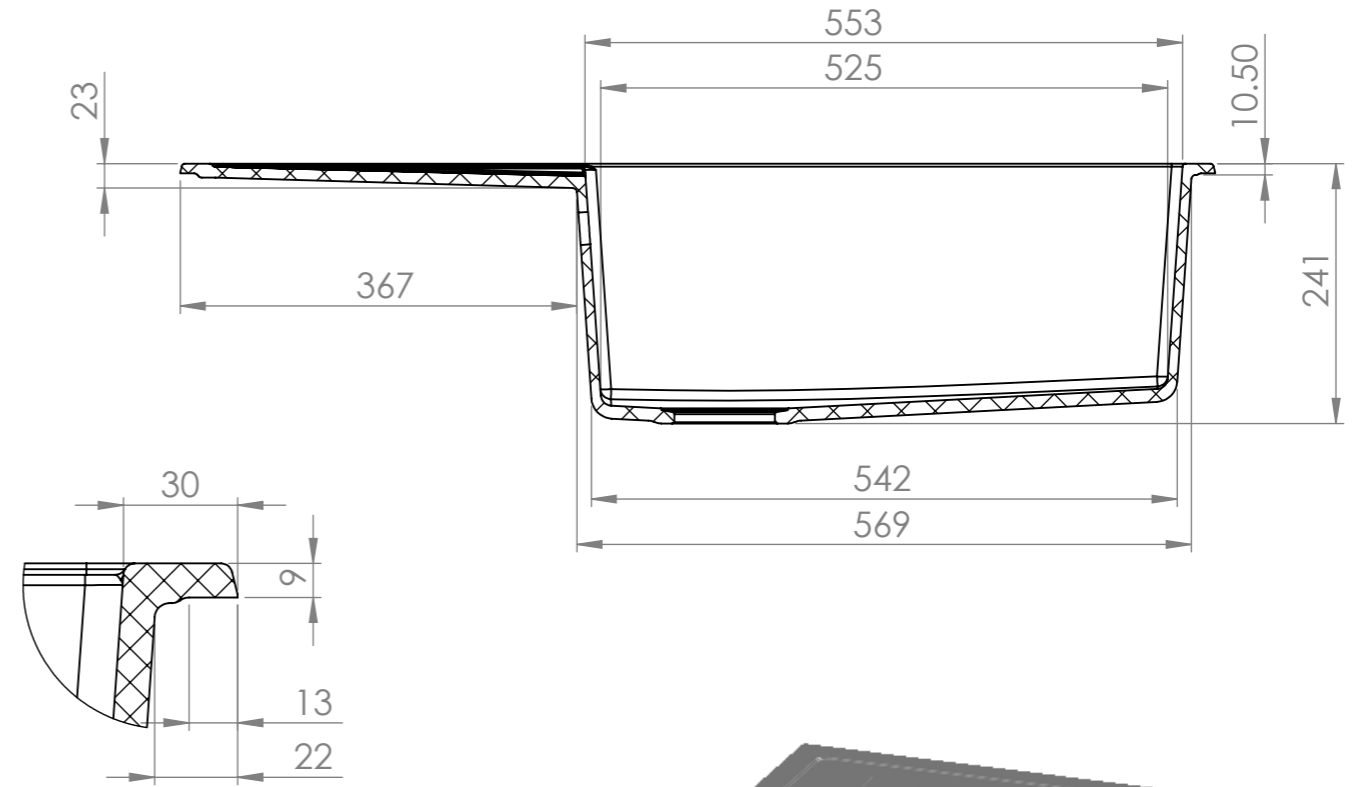

DETAIL C
SCALE 1 : 2

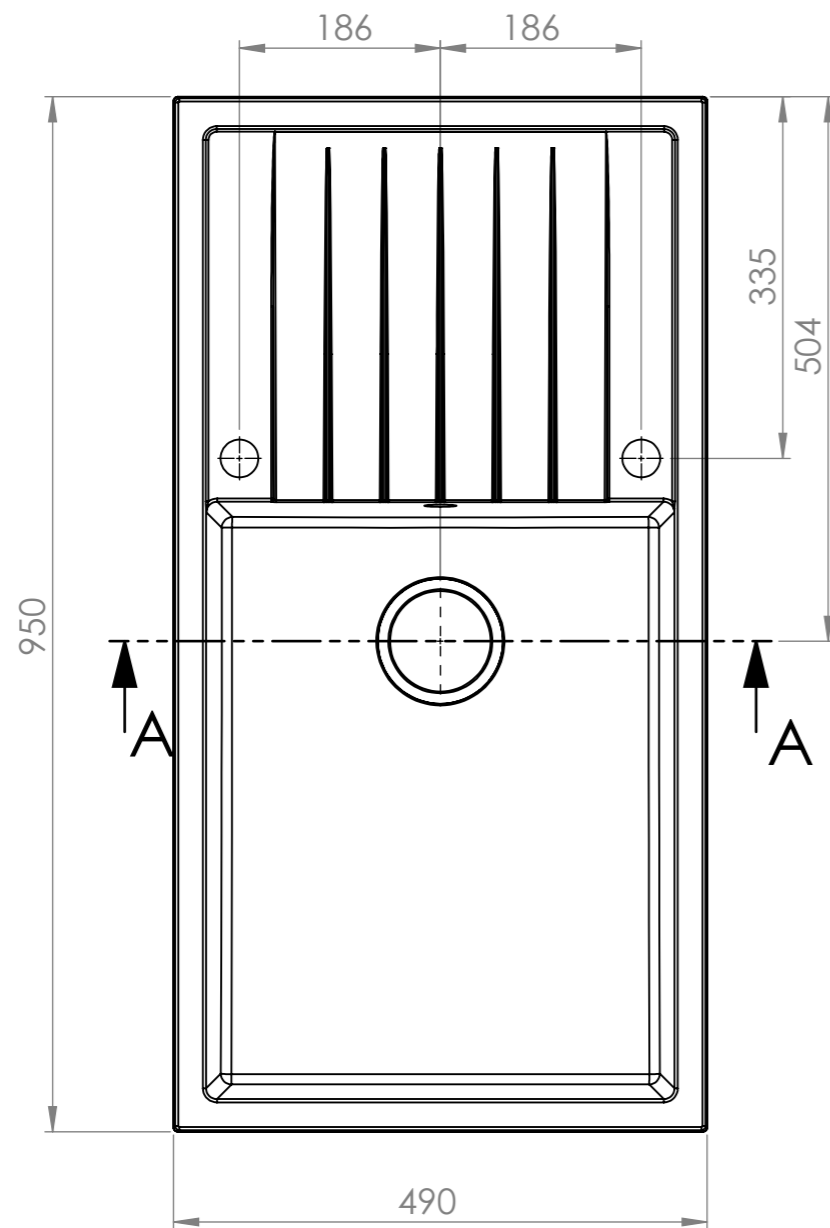
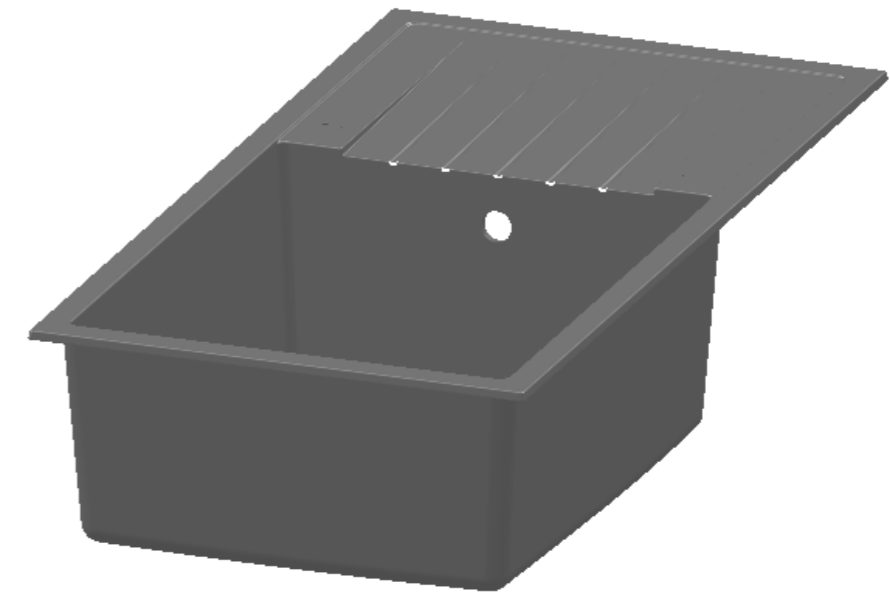

				Машаб	Маса	
				1:7		
				Лист	230	
				1		
Изм.	Описание	Подпис	Дата	"ФАТ" ЕООД		
Разр.						
Пров.						
Срок						